

Datasheet



E3 LED Edgelight - DALI Emergency



CAT. NO. 684437/D, 684443/D, 684431/D, 684432/D, 684433/D, 684439/D, 684440/D,
684441/D, 684434/D, 684435/D, 684436/D



684432/D + 684437/D

Operating Mode	Maintained
Nominal Input Voltage	230 - 240 V a.c. 50 Hz
Battery	NiMh 3.6 V 2.4 Ah
Power Consumption	2.6 W (High rate charge) 1.8 W (Low rate charge)
Inrush Current	10 A peak
Light Source Life (LSL)	50,000 hrs
Operating Temperature	10° C to 40° C
Body Construction	Stainless steel wall plate and Steel for Surface Mounting Block
Diffuser Construction	Acrylic
IP Rating	IP20
Compliance	AS/NZS 2293, AS/NZS 60598
Product Marking	  

E3 LED Edgelight - DALI Emergency

CAT. NO. 684437/D, 684443/D, 684431/D, 684432/D, 684433/D, 684439/D, 684440/D,
684441/D, 684434/D, 684435/D, 684436/D



FEATURES

- Internally illuminated sign with no classification.
- Recessed or Surface Mounted.
- Modern and sleek design.
- 1 Year Warranty.
- Designed and Manufactured in Australia.

DIMENSIONS

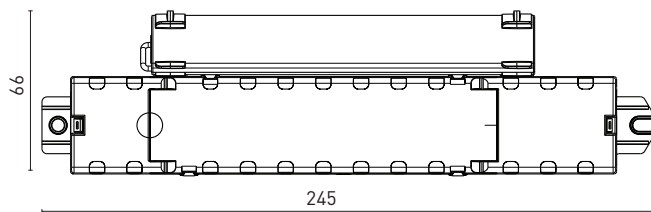

Power pack- Recessed

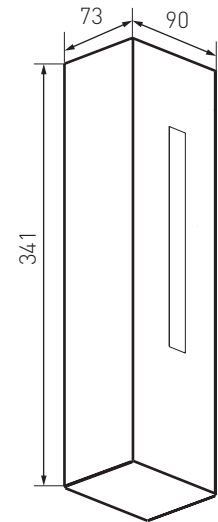
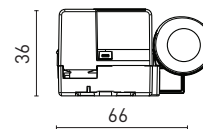

Power pack-Surface Mount

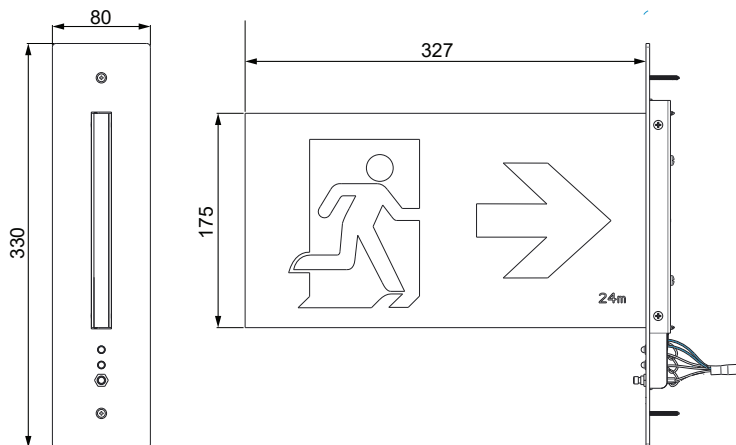

Diffuser with wall plate

NOTE: All dimensions are in mm.

E3 LED Edgelight - DALI Emergency

CAT. NO. 684437/D, 684443/D, 684431/D, 684432/D, 684433/D, 684439/D, 684440/D,
684441/D, 684434/D, 684435/D, 684436/D



Note: For complete luminaire order power pack and Diffuser with wall plate.

POWER PACK – RECESS INSTALLATION	
Cat. No	Description
684437/D	E3 power pack

POWER PACK – FOR SURFACE INSTALLATION (Includes mounting block)	
Cat. No	Description
684443/D	E3 surface mount power pack – Silver finish

DIFFUSERS WITH WALL PLATE		
Cat. No	Description	
684431/D	E3 LED – wall to left – Single Sided – RMS	
684432/D	E3 LED – wall to left – Single Sided – RML	
684433/D	E3 LED – wall to left – Single Sided – RMR	
684439/D	E3 LED – wall to right – Single Sided – RMS	
684440/D	E3 LED – wall to right – Single Sided – RML	
684441/D	E3 LED – wall to right – Single Sided – RMR	
684434/D	E3 LED – wall to left – Double Sided – RMS	
684435/D	E3 LED – wall to left – Double Sided – RMLR	
684436/D	E3 LED – wall to left – Double Sided – RMLR	

RMS = Running Man Straight, RML = Running Man Left,
RMR = Running Man Right, RMLR= Running Man Left or Right

Legrand Australia
1300 369 777
www.legrand.com.au
ABN 31 000 102 661

Legrand New Zealand
0800 476 009
www.legrand.co.nz

Refer to your group buying office, Legrand Sales Representative or
Legrand Sales Office for pricing.

Please note: specifications are subject to change without prior notice.

